



90



ARCKIT is a multi award-winning precision architectural model building system that lets you physically design, build and modify a scaled structure faster than ever before. It's easy to use and quick enough to keep up with even the fastest imaginations.

NOW LET'S START BRINGING YOUR IDEAS TO LIFE!

QUICK START GUIDE



CONTENT:

- INTRODUCTION
- IN THE BOX
- COMPONENT GUIDE
- CONSTRUCTION PROCESS
- MORE CONTENT!

THE ARCKIT STORY

Architects have always used physical working models as a means to explore and communicate ideas. Today however, cutting and gluing materials together is no longer feasible due to time and cost constraints involved.

I still believe that physical models are essential for collaboration between architects and clients and so I wanted to develop a new system that would rekindle model making.

The inspiration for Arckit came about while I was developing a real modular building concept. In essence Arckit is a miniaturisation of this modern building technique, consisting of interconnecting components that enable multiple building options.

It's fast, flexible and reusable, offering an immediate canvas for spontaneous creativity. By removing technical barriers, Arckit is for the first time opening up architectural design and precision scaled model making to everyone.

Since we first launched, Arckit has become increasingly popular as a fun and highly educational design tool. We really value ideas from the Arckit community and we are continually striving to evolve and enhance the system, starting with our latest edition kits.

I hope that your new kit brings you many hours of happiness and creativity.



Damien Murtagh
Architect
Founder CEO
ARCKIT



Photo Credit: @filbertdkung

ARCKIT is a freeform model building system that allows you to physically explore ideas and bring your architectural designs to life.

The system uses interconnecting components that are completely modular, making it possible to create a diverse range of scaled structures that can be endlessly modified and finished to perfection.

ARCKIT also integrates with 3D modelling software and other add-ons such as bespoke 3D printed components and a series of STEM Education Programmes for schools and community projects.

Find out more at www.arckit.com

**DESIGNED BY
ARCHITECTS**

INTRODUCING

Immerse yourself in the ultimate Arckit experience with Arckit 90. Everything you need to build a diverse range of impressive model structures up to 90 sq.m (960 sq.ft) to scale, including adhesive sheets to add realistic building finishes.

Arckit 90



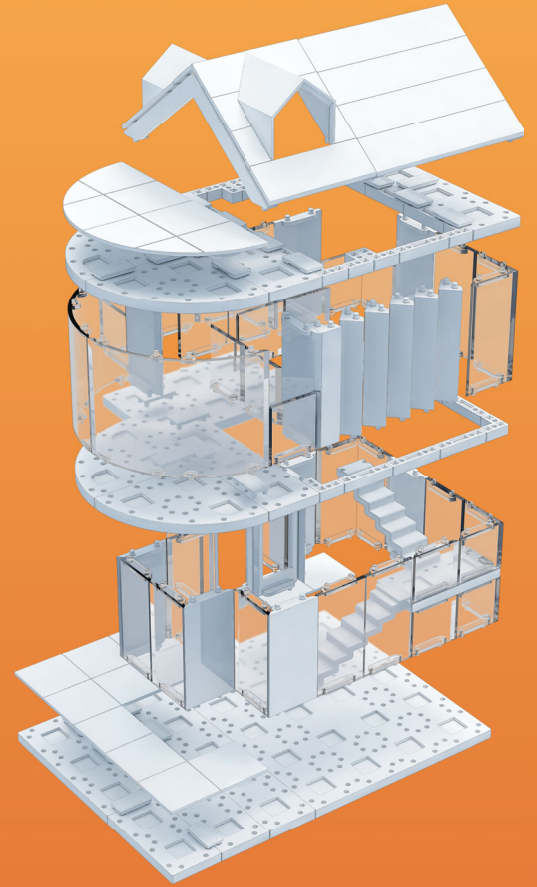

IN THE BOX

Total: 220+ pcs

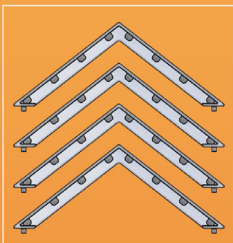

ROOF TRUSS - 5.02
x4

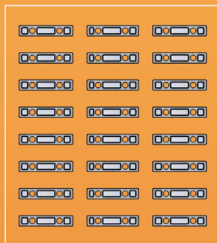

WALL JOINT - 9.01
x24

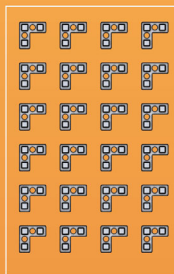

WALL JOINT CORNER - 9.02
x24

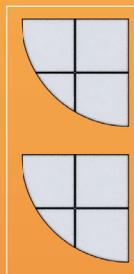

TILE CURVE - 5.07
x2

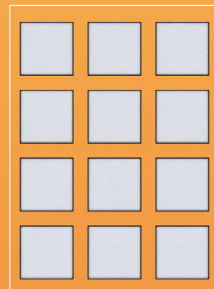

TILE - 5.01
x12

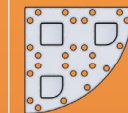
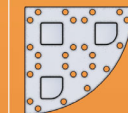
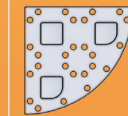
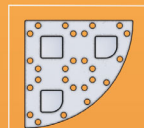

FLOOR CURVE 2 - 1.07
x4

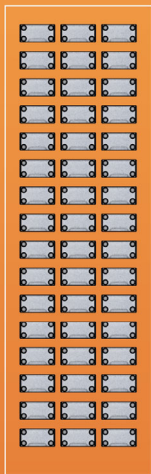

LINK - 8.01
x48

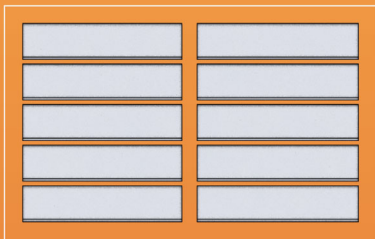

ROOF TILE 3 - 6.02
x10

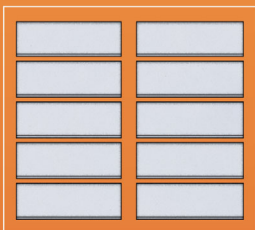

ROOF TILE 2 - 6.01
x10



DORMER - 6.03
x2



STAIR - 10.01
x2

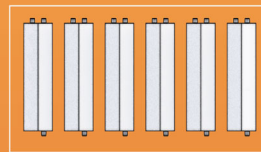

COLUMN - 11.01
x6

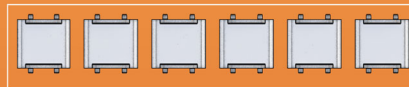

WALL LOW - 2.05
x6

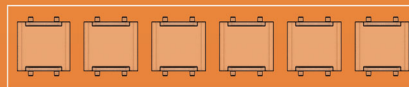

WALL LOW CLEAR - 2.07
x6



RAILING CLEAR - 2.06
x12

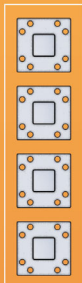

FLOOR 1 - 1.01
x4

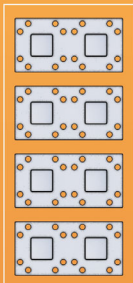

FLOOR 2 - 1.02
x4

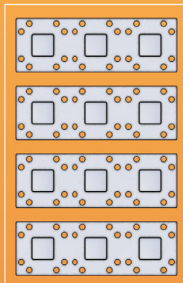

FLOOR 3 - 1.03
x4

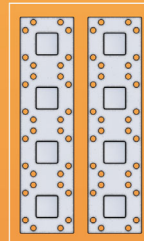

FLOOR 4 - 1.04
x2

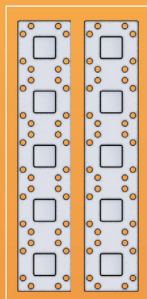

FLOOR 5 - 1.05
x2

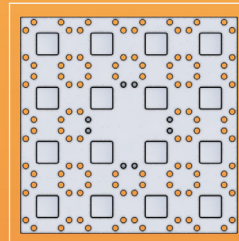

FLOOR 4 X 4 - 1.10
x1

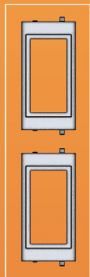

WINDOW
3.01
x2



WINDOW CORNER
3.02
x2

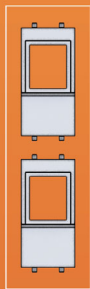

WINDOW PICTURE
3.03
x2

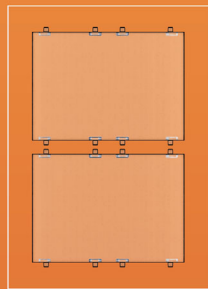

WALL CURVE CLEAR 2 - 2.11
x2

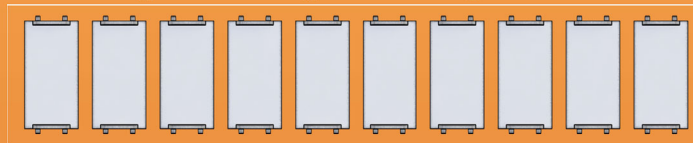

WALL - 2.01
x10

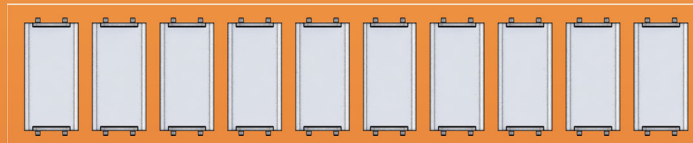

WALL CORNER - 2.02
x10

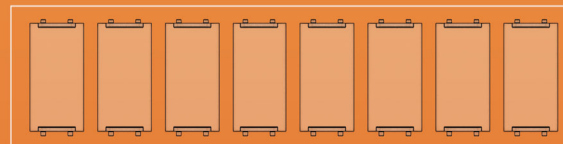

WALL CLEAR - 2.03
x8

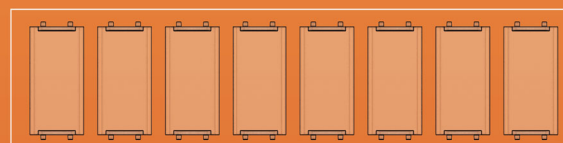

WALL CORNER CLEAR - 2.04
x8

ARCKITEXTURE® 5x A5 Pre-printed self adhesive sheets
5x A4 blank self adhesive sheets - textures available online

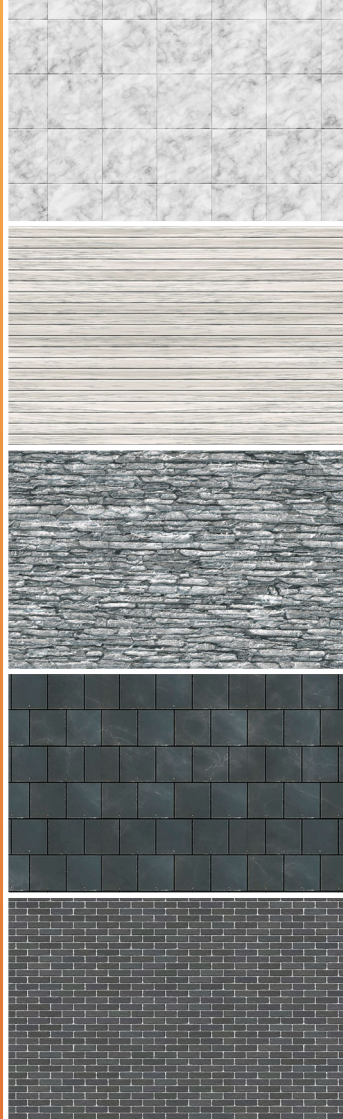

A90

The following sample building instructions are simply to familiarise you with Arckit's reusable system & to get you on your way with your own creations.

Go online for exciting interactive 3D construction videos and more building instructions:

REQUIRES QR CODE SCANNER VIA APP STORE!

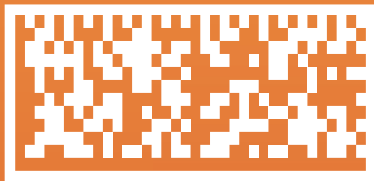

WWW.ARCKIT.COM

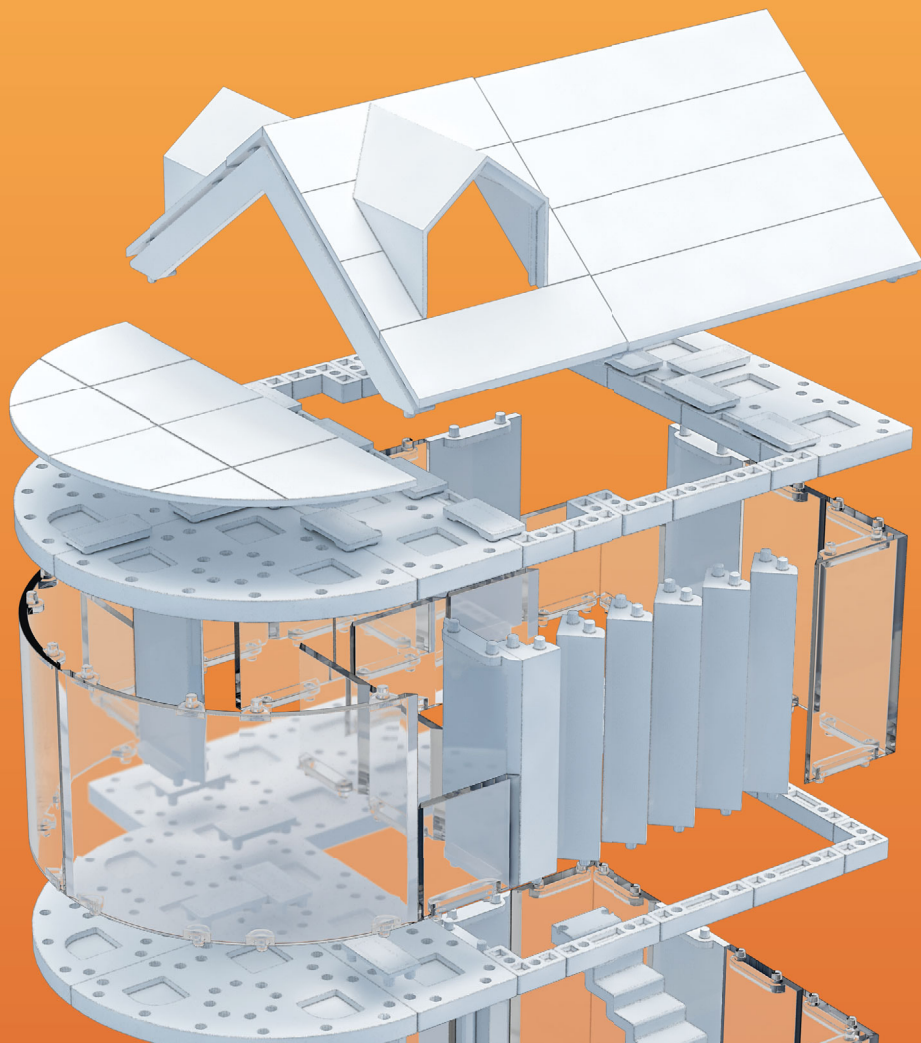

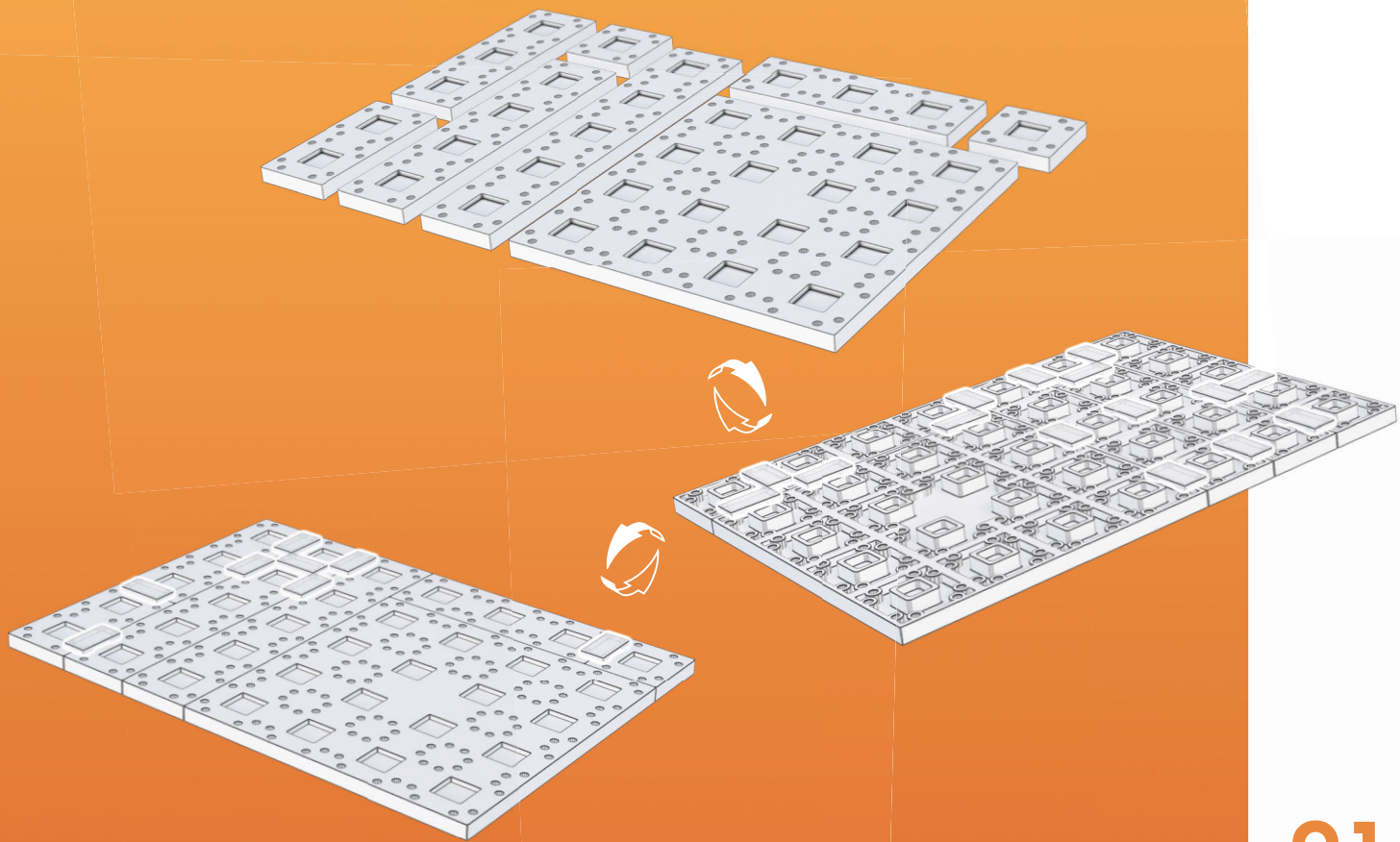

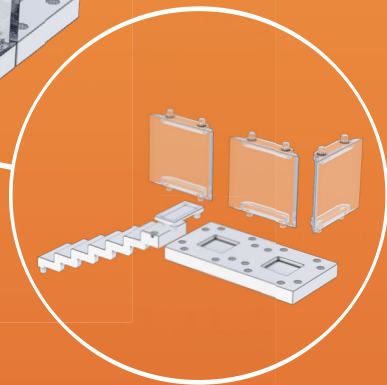
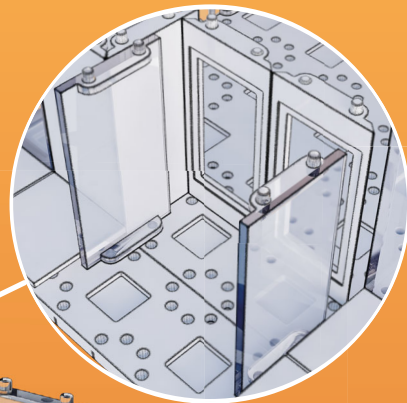
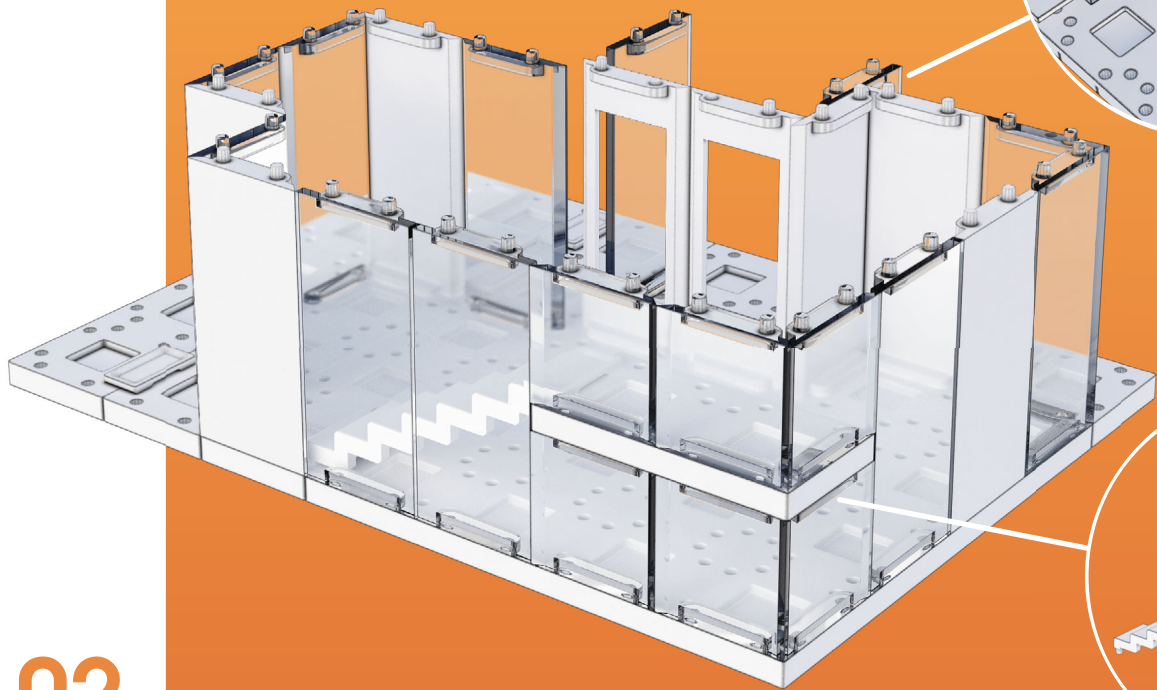

02

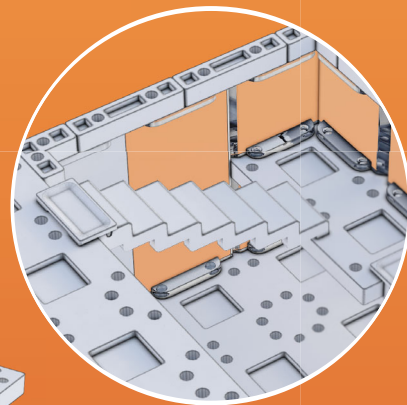
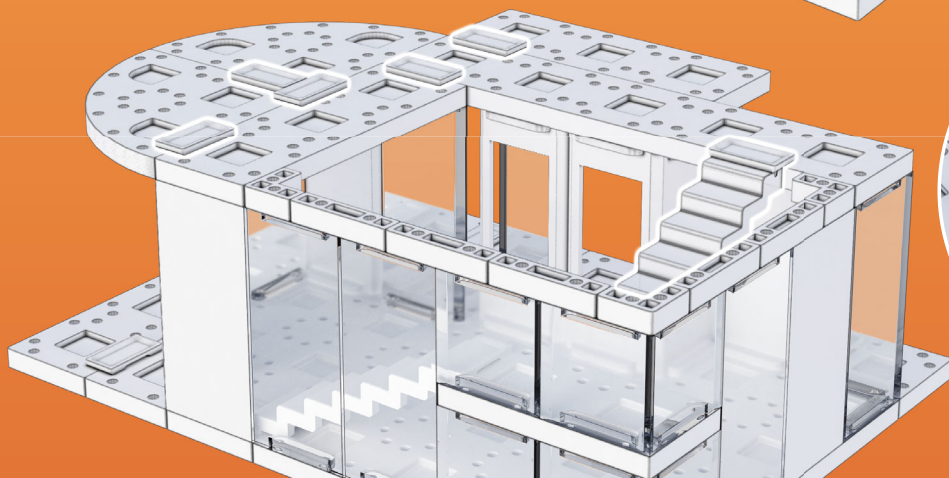
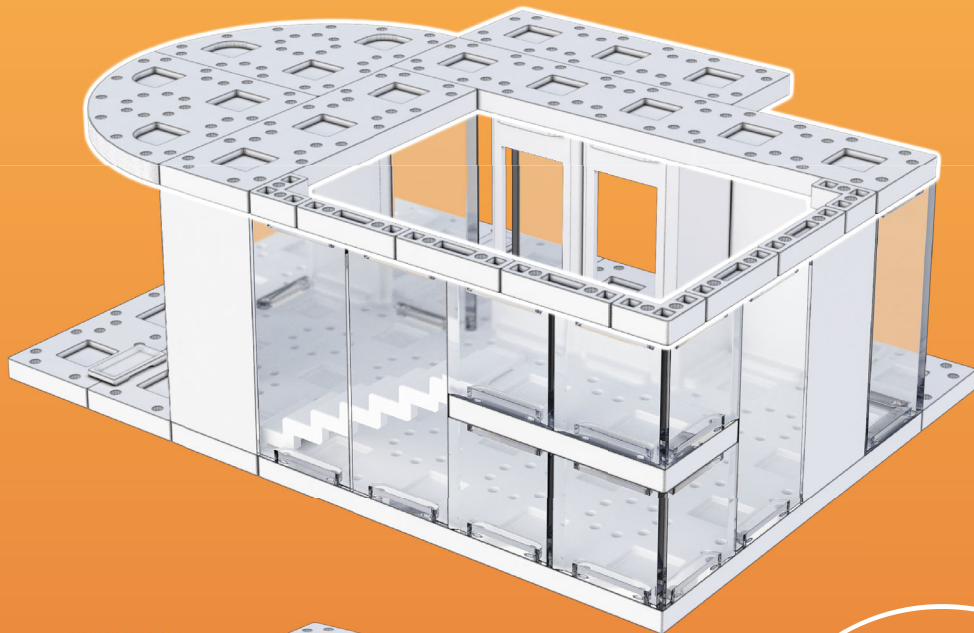

03

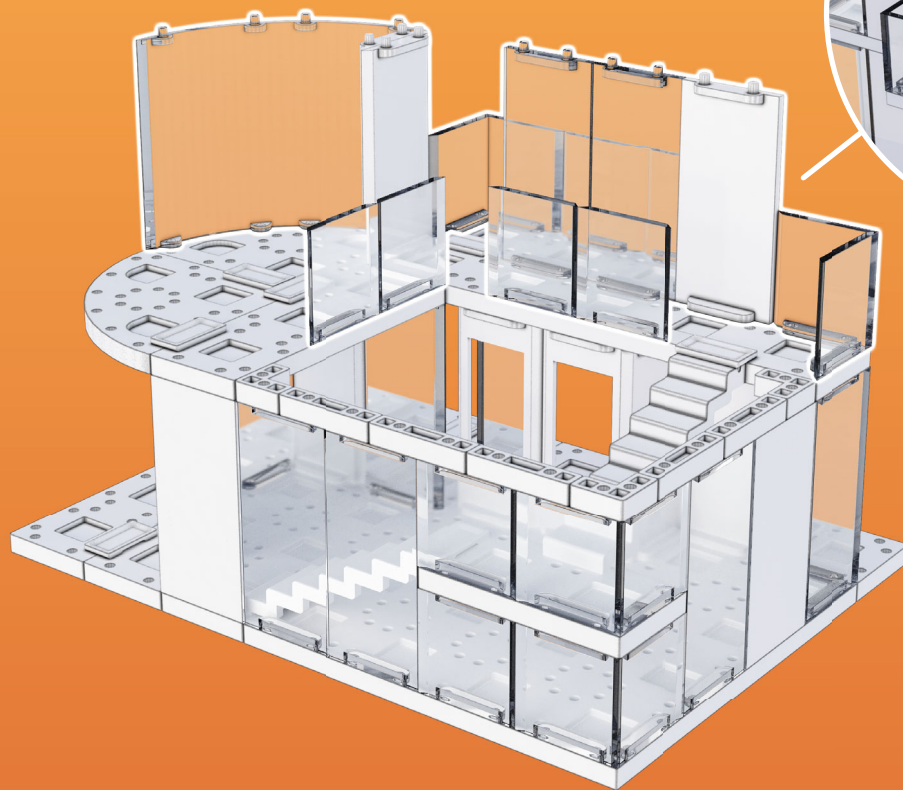

04

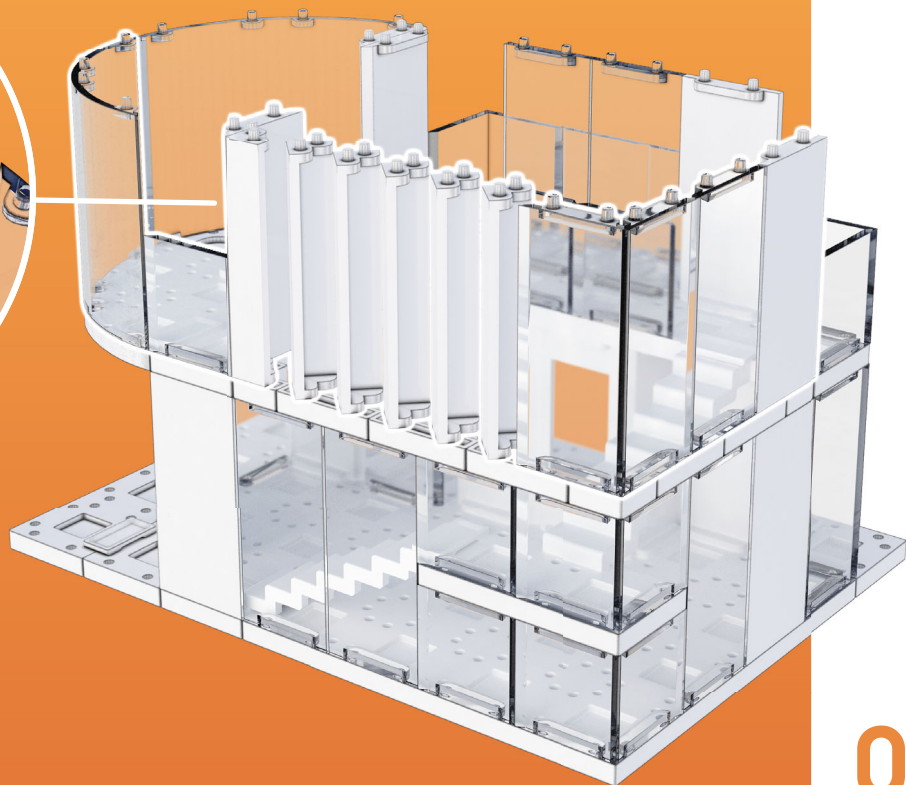
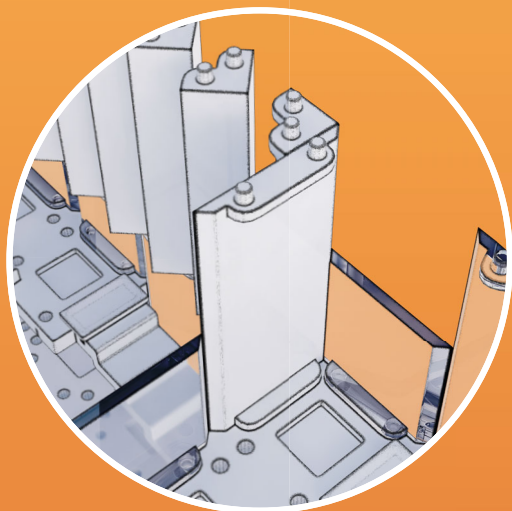

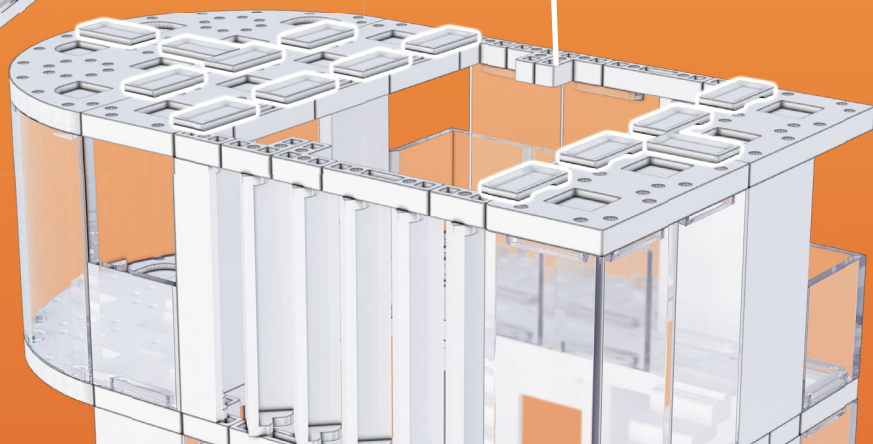
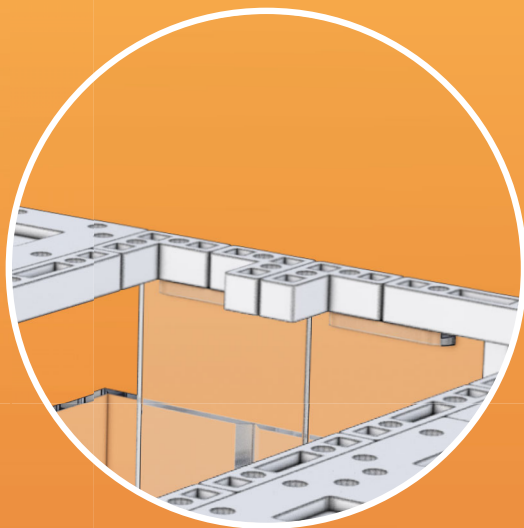
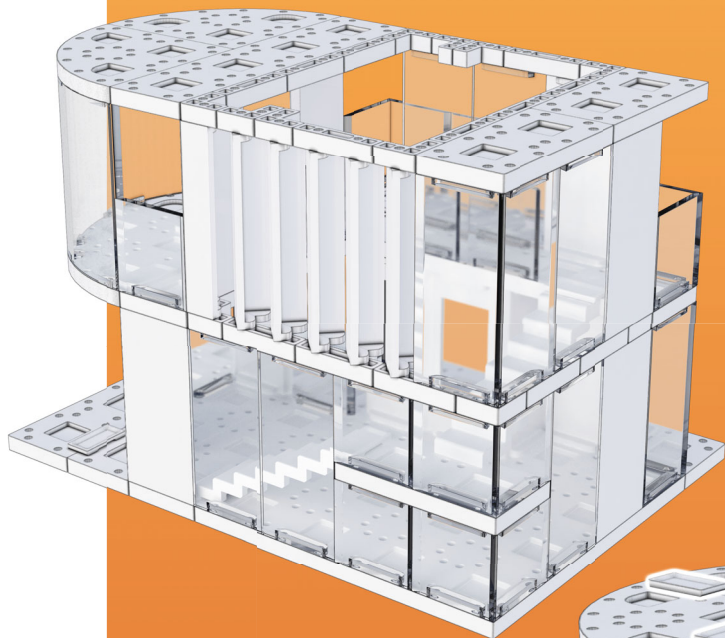

06

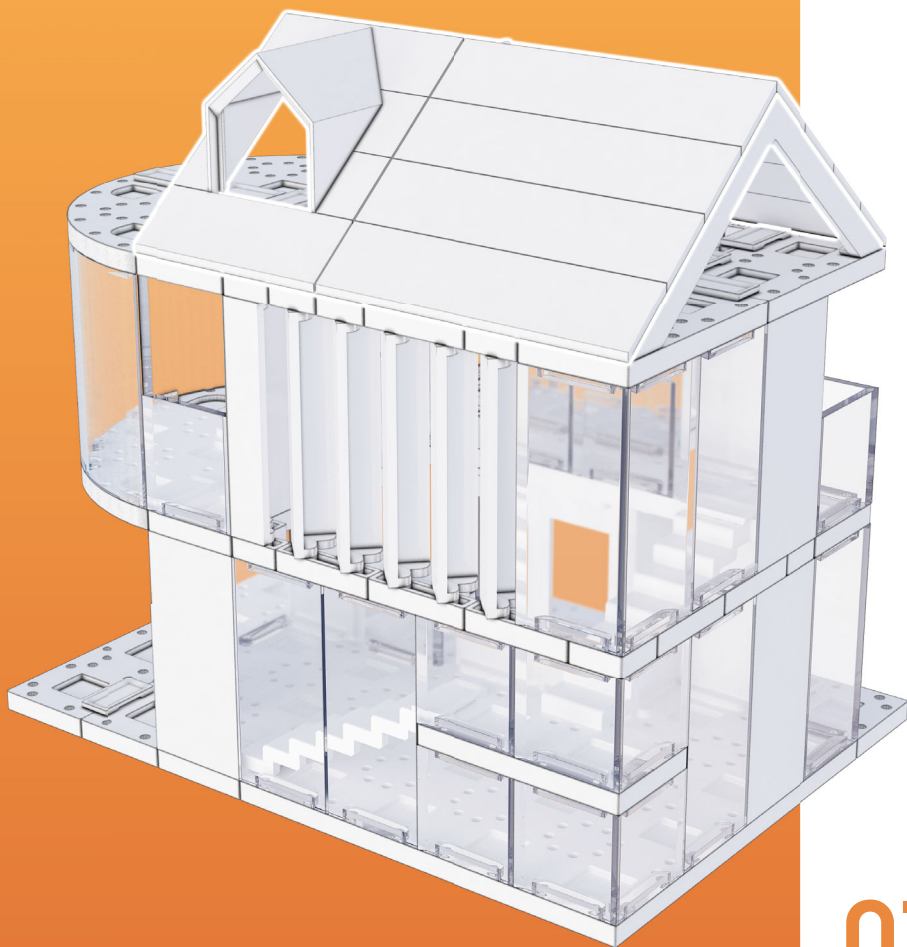
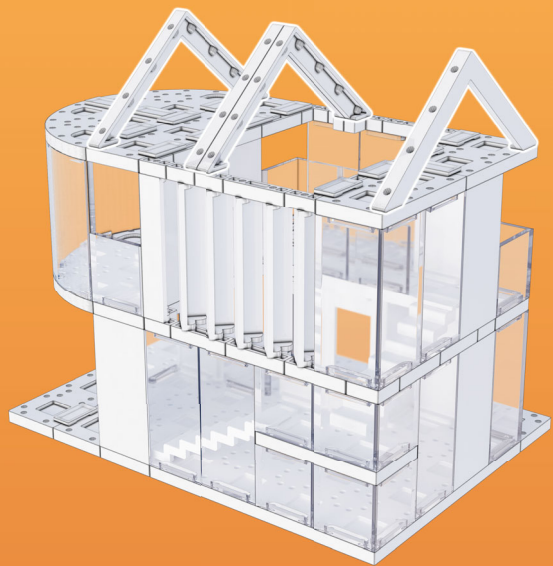

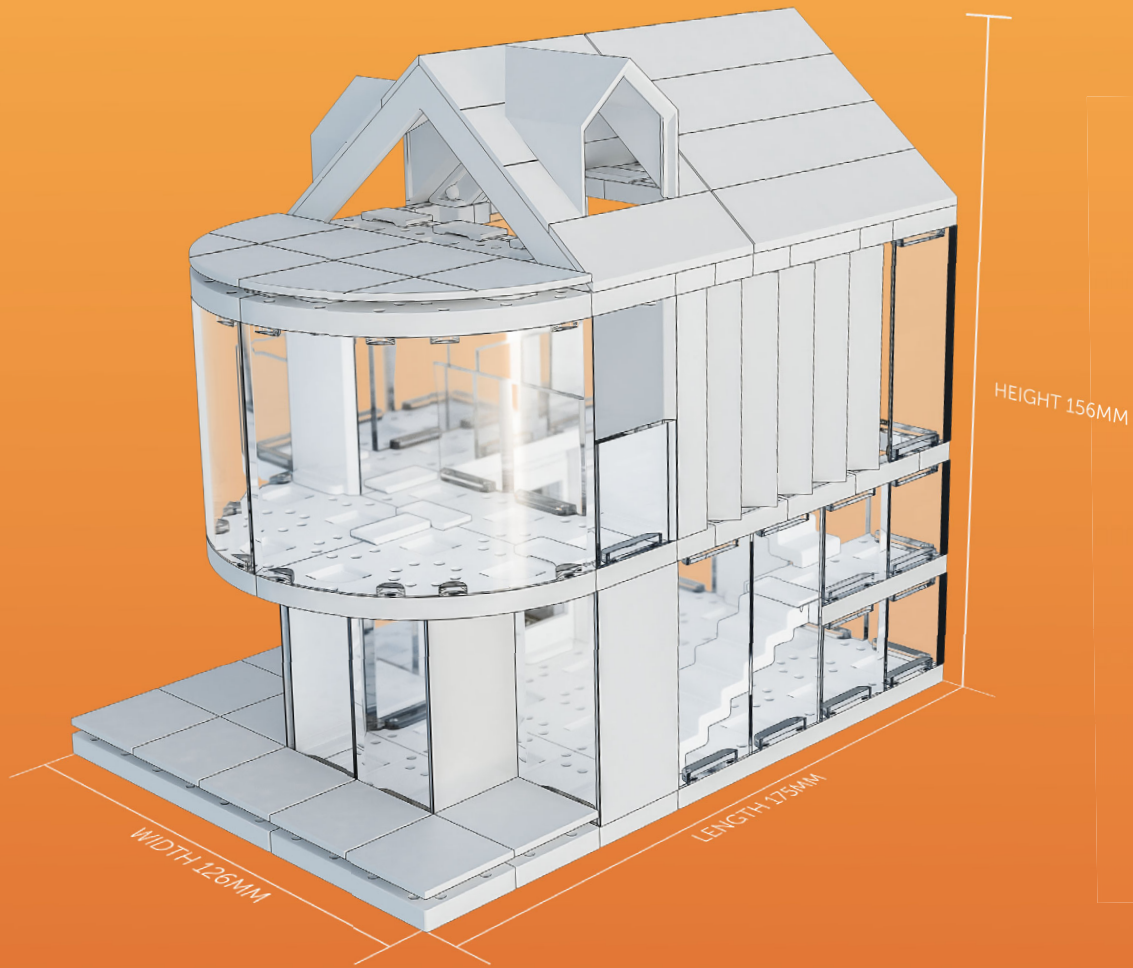

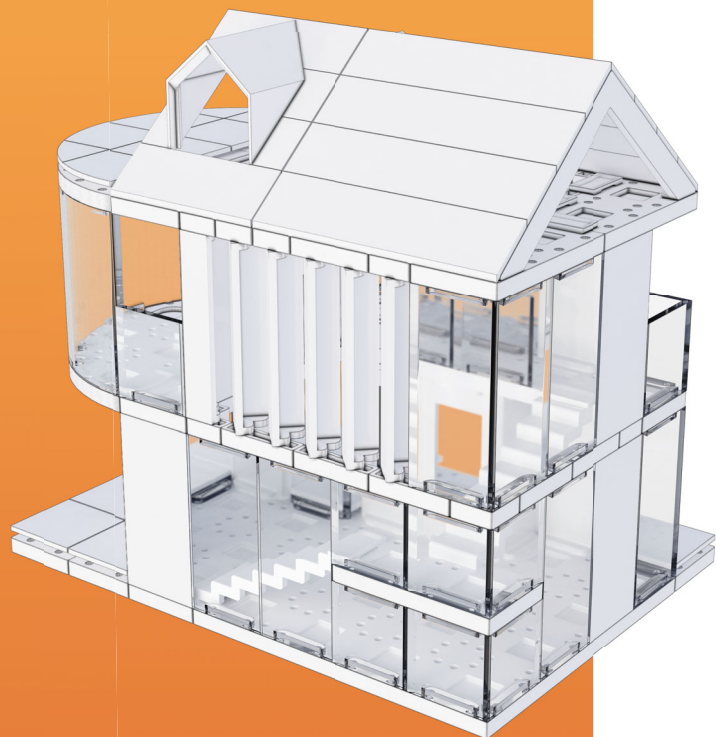
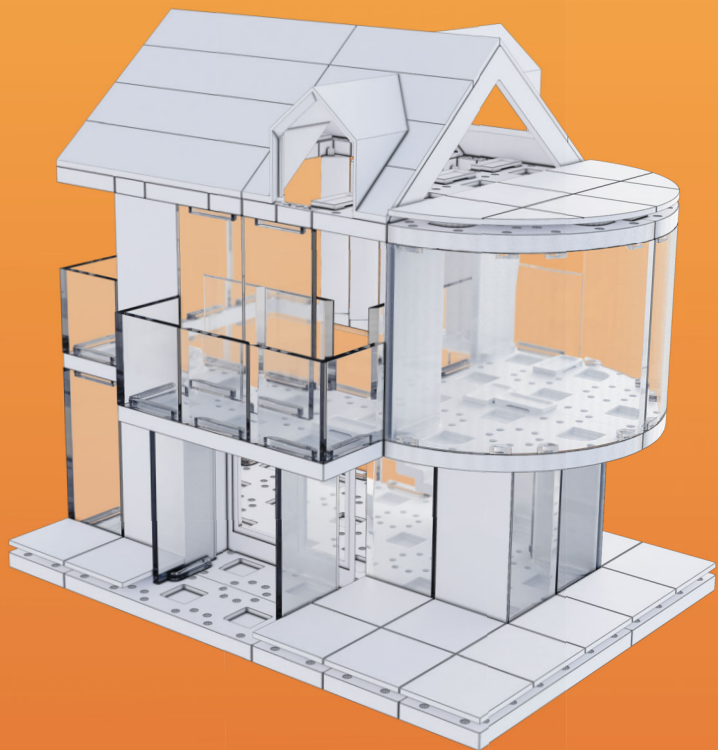

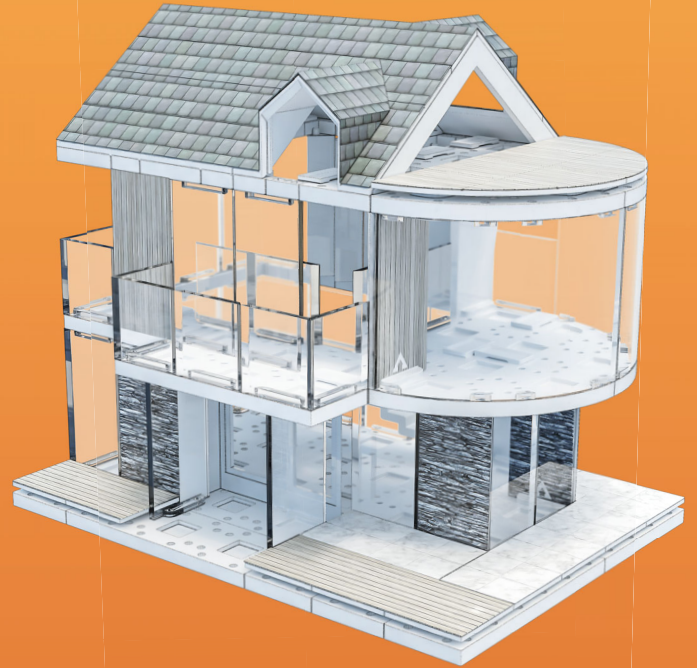

Finish by measuring, cutting and applying textures to your model as desired.

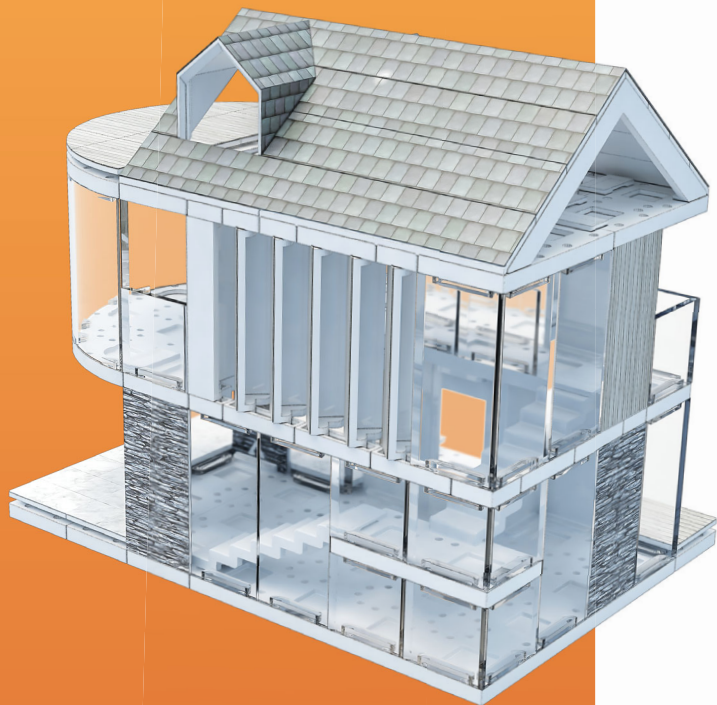
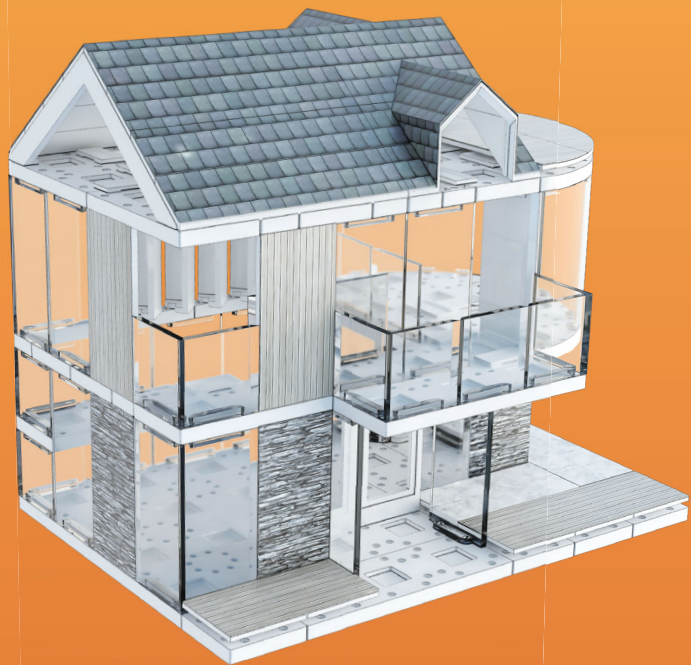

WWW.ARCKIT.COM

Come visit us online for more content!

ARCKITTEXTURE®

Free access to a digital library of material textures to print off and apply realistic finishes to your structures.

ARCKITDIGITAL®

Design and Build your structures virtually using Arckit digital components within SketchUp.

ARCKIT INFINITI•3D

Online 3D printed component store. Opening up unlimited potential for new bespoke components to integrate into the Arckit model building system and allowing users to further enhance their existing Arckit collection with specialist 3D printed parts.



REQUIRES QR CODE SCANNER VIA APP STORE!

Explore endless possibilities, share your creations and be inspirational!



&



@arckitmodel



facebook.com/arckit



Legal Information

Legal Notice and Terms of Use for www.arokit.com

Please read these terms and conditions carefully before using the Arkit website. If you do not agree to them, please don't use this website. By accessing, browsing, using, framing and/or linking to this website ("Site"), you acknowledge that you have read, understand, and agree to be bound by these terms and to comply with all applicable laws and regulations.

This Site is owned and run by MBM Building Systems Ltd., a company incorporated under the laws of Ireland ("MBM"). Material displayed on this website may be downloaded by you for your personal (non-commercial), use only, provided you keep intact all copyright, trademark and other proprietary notices. The design and layout of this website are specifically excluded from the Material. Please note that any reproduction, republishing, copying, transmission, uploading, posting or distribution of any content from this website for public or commercial purposes, is expressly prohibited without prior written permission from MBM.

Terms and Conditions

1. Save as expressly provided otherwise, all content you see or read on this website is protected by copyright and may only be used according to these terms and conditions. MBM does not warrant or represent that your use of materials displayed on this website will not infringe rights of third parties. Images displayed on this website are either the property of, or used with permission by, MBM. Save as expressly provided otherwise herein, the use of such images by you, or anyone else authorized by you, is expressly prohibited. Please note that any unauthorized use of such images may violate copyright, trademark, privacy and publicity laws, and communications regulations and statutes.

2. MBM makes no warranties or representations as to the accuracy of the information on this website and assumes no liability or responsibility whatsoever for any errors or omissions contained therein. MBM uses reasonable efforts to include accurate and up-to-date information on this website.

3. Your use of and browsing in this Site is at your risk.

THE INFORMATION ON THIS SITE IS PROVIDED "AS IS" WITHOUT WARRANTY OF ANY KIND, EITHER EXPRESS OR IMPLIED, INCLUDING, BUT NOT LIMITED TO, THE IMPLIED WARRANTIES OF MERCHANTABILITY, FITNESS FOR A PARTICULAR PURPOSE, AND NON-INFRINGEMENT. MBM SHALL NOT BE LIABLE FOR ANY DAMAGES SUFFERED BY OR INJURY CAUSED TO YOU, INCLUDING ANY DIRECT, INDIRECT, SPECIAL, CONSEQUENTIAL, AND/OR INCIDENTAL DAMAGES, RESULTING FROM YOUR ACCESS TO, OR INABILITY TO ACCESS, THIS SITE, OR FROM YOUR RELIANCE ON ANY INFORMATION PROVIDED IN THE SITE, EVEN IF MBM AND/OR ITS AFFILIATES HAVE BEEN ADVISED OF THE POSSIBILITY OF SUCH DAMAGES.

4. All correspondence or material sent from you to the Site by email or other modes of transmission, including data, questions, comments or suggestions, photos, videos, software or otherwise, will be considered non-confidential and not private in character. Everything that you transmit or post there may be used by MBM or its subsidiaries for any purpose. Furthermore, MBM reserves the right to use any ideas, concepts, expertise or techniques contained in any communication sent from you to the Site for any purpose whatsoever, including but not limited to, developing, manufacturing and the commercialization of products by using such information.

5. The trademarks and logos on the Site are the exclusive property of MBM, or used with the permission of their owners. Any reproduction, use, and/or modification of these images without prior written authorization from MBM constitutes trademark infringement and will be pursued in the appropriate courts. Nothing contained on the Site should be construed as granting, by implication, estoppel, or otherwise, any license or right to use any trademark displayed on the Site without the written permission of MBM or such third party that may own the trademarks displayed on the Site.

Services, technology, and/or processes referenced and described in this Site are the subject of intellectual property rights reserved by MBM including, without limitation, those certain patent and trademark rights expressly identified below. Nothing contained herein shall be construed as conferring to you personally, or to your organization in any manner, whether by implication, estoppel or otherwise, any license, title, interest or ownership of or to any intellectual property right of MBM.



IMAGINE IT. BUILD IT.